



شرکت زاگروس کاروسل

ZAGROS Karussell Co.

تهران، شهر قدس، بلوار کلهر، بلوار شهیدا، خیابان ساحل، خیابان سرو، پلاک ۱۵ - کد پستی: ۳۷۵۱۱۳۳۵۳  
تلفن: ۰۹۱۲ ۲۱۸۱ ۷۲۹ - ۰۹۰۳ ۵۱۳۹ ۲۴۰ - ۰۹۰۳ ۲۷۱۰ ۵۵۰

No. 15, Sarv-E-Sharghi St., Sahel St., Shohada Blvd., Kalhor Blvd,  
Shahr-E-Qods, **Tehran, IRAN Postal Code: 375113353**

Tel: +98912 2181 729 - +98903 5139 240 - +98903 2710 550

[zagroskarussell.irex2world.com](http://zagroskarussell.irex2world.com)

[zagroscarusel@gmail.com](mailto:zagroscarusel@gmail.com)



+989121692052

zagroskarusel@gmail.com

شهر قدس - بلوار کهر - بلوار شهیدا -  
خیابان ساحل - خیابان سرو - پلاک ۱۵

شرکت زاگرس کاروسل  
سازنده کاروسل های CNC با ابزار زنده

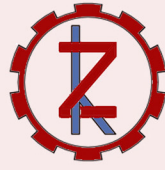

ZAGROS KARUSSELL Co  
Vertical Lathe

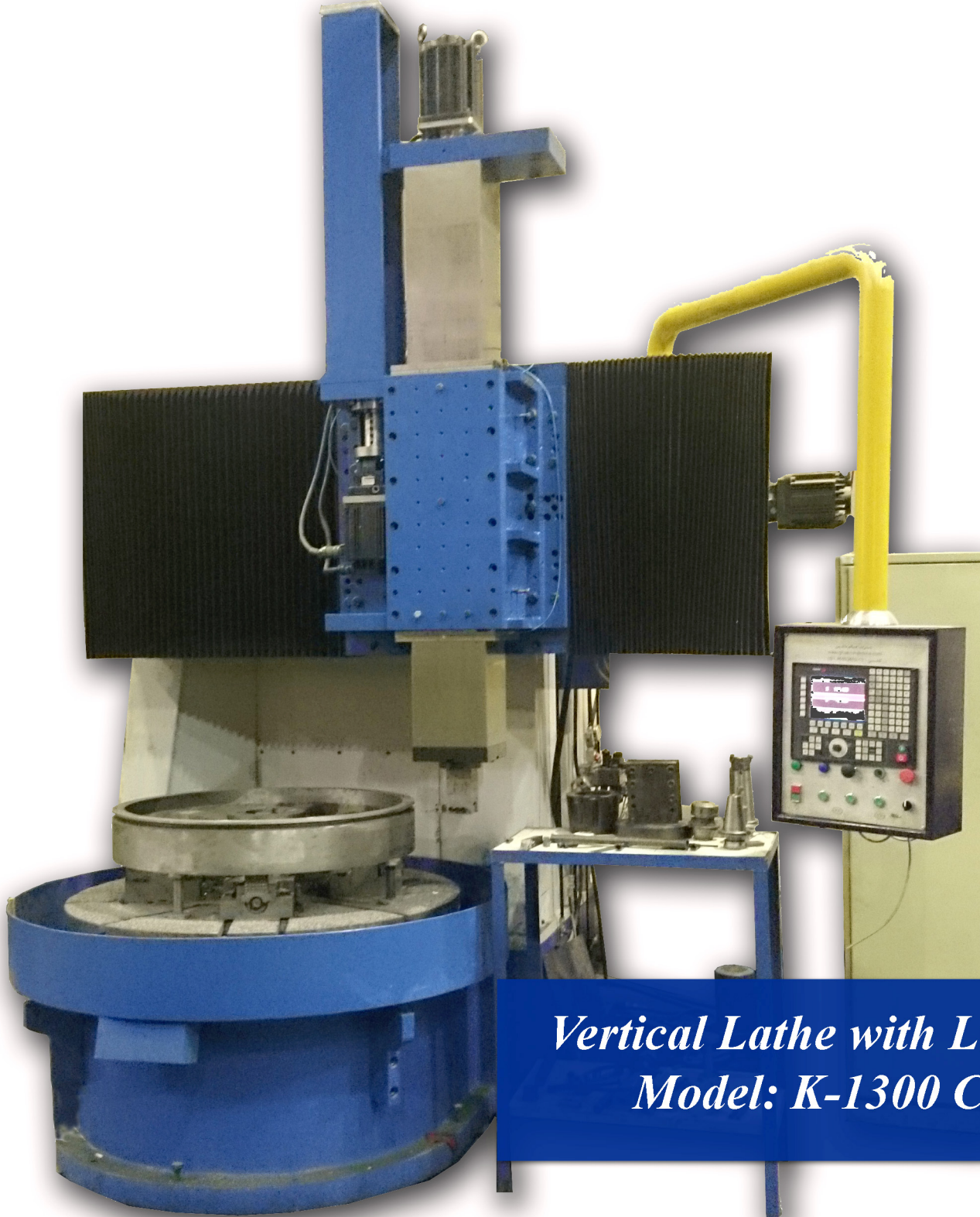

*Vertical Lathe with Live Tool  
Model: K-1300 CNC*



+989121692052

zagroskarusel@gmail.com

شهر قدس - بلوار کهر - بلوار شهیدا -  
خیابان ساحل - خیابان سرو - پلاک ۱۵

شرکت زاگرس کاروسل  
سازنده کاروسل‌های CNC با ابزار زنده



ZAGROS KARUSSELL Co  
Vertical Lathe



*Vertical Lathe Power Chuck  
Model: K-1000 CNC*



شرکت زاگرس کاروسل  
سازنده کاروسل‌های CNC با ابزار زنده

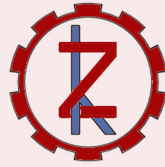

ZAGROS KARUSSELL Co  
Vertical Lathe

*Vertical Lathe with movable Cross  
Model: K-2000 CNC*

+989121692052

zagrosrosel@gmail.com

شهر قدس - بلوار کلهر - بلوار شهیدا -  
خیابان ساحل - خیابان سرو - پلاک ۱۵





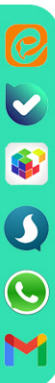

+989121692052

zagrosrosel@gmail.com

شهر قدس - بلوار کلهر - بلوار شهدا -  
خیابان ساحل - خیابان سرو - بلاک ۱۵

Main Spindle /Table is on a Cross Roller Bearing (CRB) with 800mm Diameter for K-1000CNC

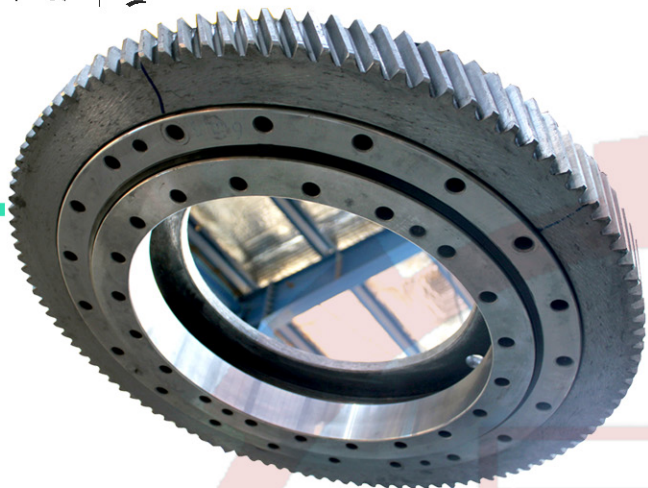

## Cross Roller Bearing

CRB will Made a strong and permanent accurate machine also very fine surface for turning



## Main Gear

CRB's accuracy is 0.005mm (radial & axial)

Lubrication of main gearbox, CRB, main gear and pinion bearings are automatically and continuous

## Main Gear & Pinion



Surface quality is 1.8 $\mu$ m

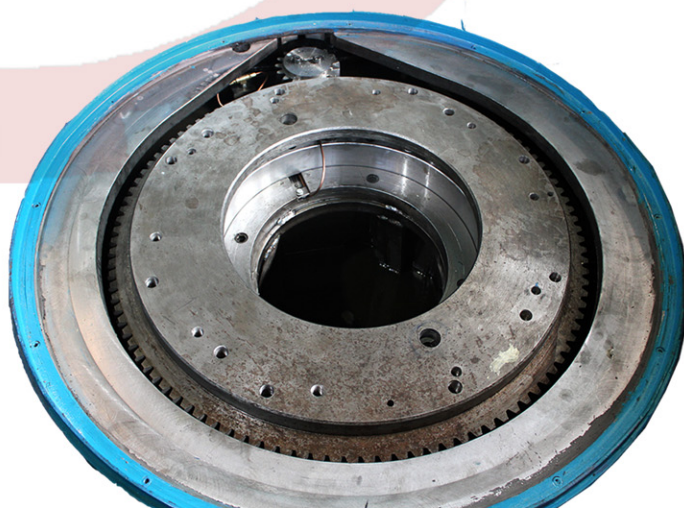

Run out max. is 0.01mm

## Power Chuck

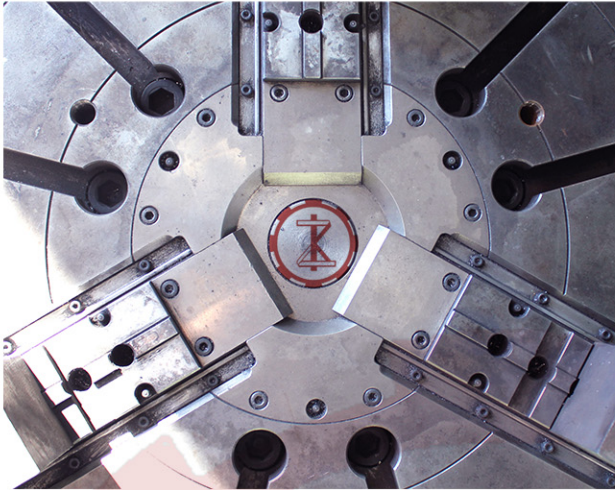

L.M Guide Roller is the maintenance free Guide (PEK) so there is no Backlash with C3 class Ballscrew (PEK)  
Linear Encoder is 5mic.

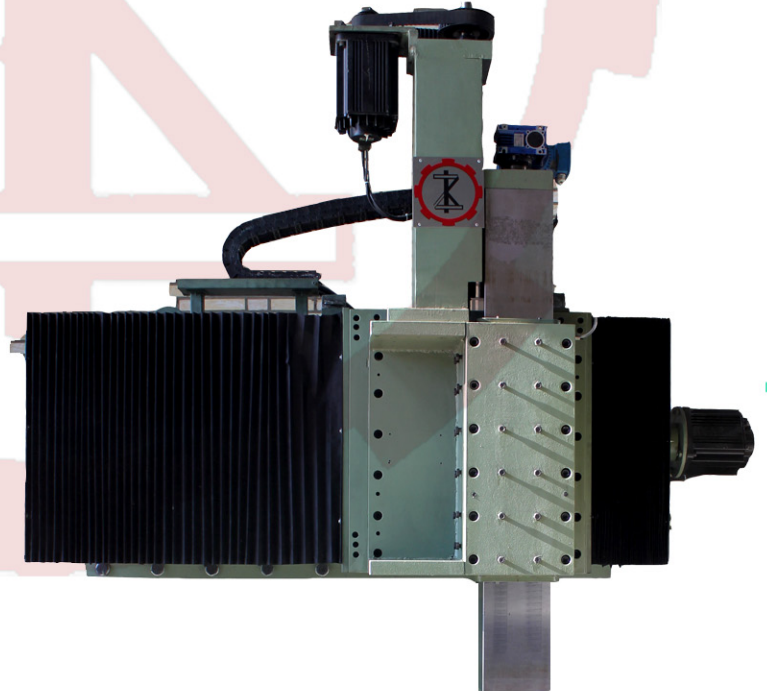
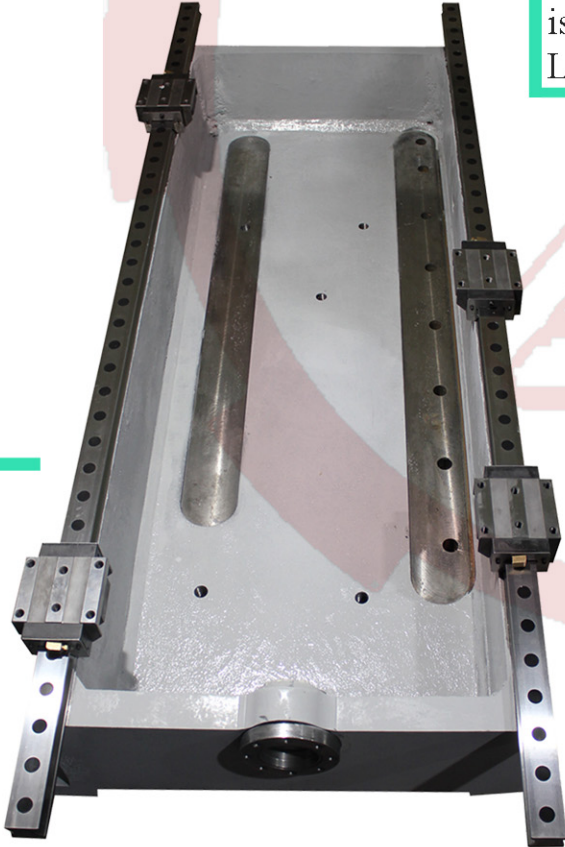

## L.M. Guide for X-Axis

X-axis is L .M. Guide Roller type 45mm (in K- 1000CNC)

+989121692052

zagrosrosel@gmail.com

شهر قدس - بلوار کهر - بلوار شهیدا -  
خیابان ساحل - خیابان سرو - پلاک ۱۵

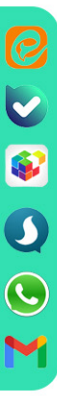



No.15 – Sarv-e-Sharqi St. – Sahel St.– Shohada Blvd. – Kalhor Blvd. –  
 Shahr-e-Qods – Tehran – Iran  
 Postal Code: 3751113353  
 +982146010314 - 09121692052 - 09032710550  
 zagroscarosel@gmail.com

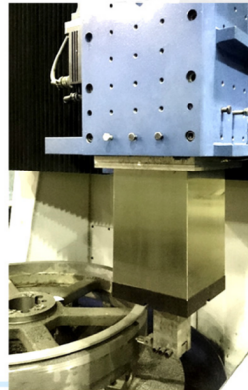
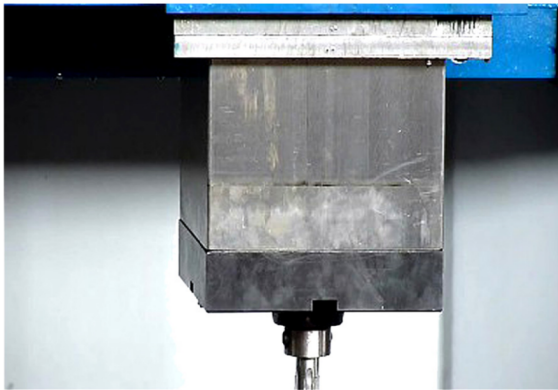
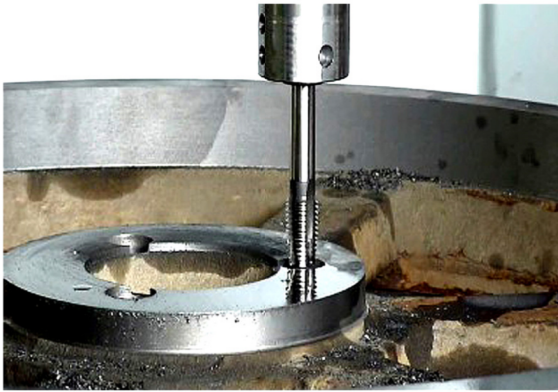

ZAGROS CAROSSEL Co.

**Table**

**Working area and tool Interference**

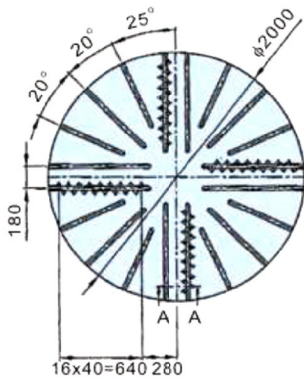

**VL-200 Series**

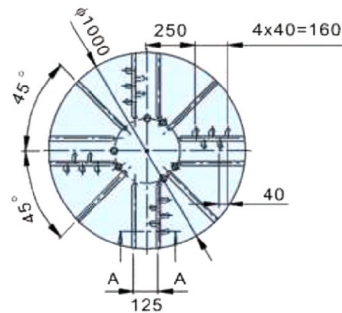

**VL-100 Series**

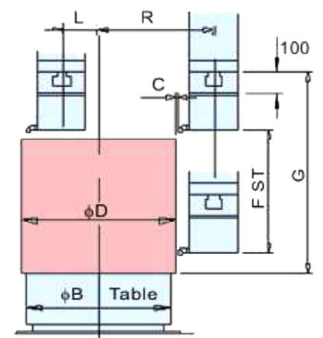
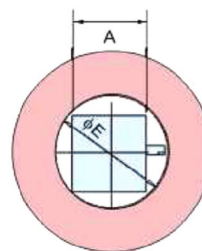

MODEL	A	̢B	C	̢D	̢E	F	G	R	L
K-1000 CNC	200	1000	100	1250	300	800	900	700	80
K-1300 CNC	200	1300	100	1700	300	880	930	1000	80
K-1600 CNC	220	1600	100	1800	330	950	1100	1100	80
K-2000 CNC	250	2000	100	2300	360	1100	650- 1200	1300	80